

SINGLE DIAPHRAGM TYPE

DIFFERENTIAL PRESSURE GAUGE



IPS-PS-21

SPECIAL FEATURES

- CE & ATEX APPROVED ELECTRICAL CONTACTS
- CASE & MEASURING SYSTEM IN SS
- DRY OR LIQUID FILLED
- STANDARD FOLLOWED IN GENERAL EN 837 - 3

APPLICATIONS

CHEMICALS / REFINERY / NUCLEAR / AEROSPACE
/ FERTILIZER / PETROCHEMICALS / PHARMACEUTICAL
/ POWER / CEMENT / SUGAR / FOOD & BEVERAGES / PULP
PAPER & ALLIED PROCESS INDUSTRIES.

SPECIFICATIONS

STANDARD VERSION : 100 mm & 150 mm

Accuracy	: ±2.5% of F. S.
Ambient temperature	: - 25°C to + 65°C
Process temperature	: Max. 100°C
Static Pressure	: 10 kg/cm ² up to ranges 600 mmWC
	: 40 kg/cm ² for ranges 1000 mmWC to 2500 mmWC
	: 60 kg/cm ² for ranges 4000 mmWC & above

☞ Static Pressure up to 100 kg/cm² on request.

Case & Bezel	: AISI 304 SS (Bayonet Type)
Diaphragm	: AISI 316L SS
Nuts & Bolts	: AISI 304 SS
Process Connection	: 1/4" NPT (F) x 2 Nos.
Seal Chamber	: AISI 304 SS
Movement	: AISI 304 SS

Protection	: IP 65
Dial	: Aluminum, black graduation on white background
Pointer	: Aluminum, black coloured, Micrometer Zero Adjustable
Window	: Shatter proof / Safety Glass
Case Gasket	: Neoprene
Scale Amplitude	: 180° to 270° (Depends on Range)

GLYCERINE FILLED VERSION (OPTION PY)

Accuracy	: ±4% of F. S.
Ambient Temperature	: Maximum 65°C
Process Temperature	: Maximum 65°C
Window	: Plexi Glass
Dampening Liquids	: Glycerin 99.7%
Other Features	: Refer Specification of Standard Version

ELECTRICAL CONTACTS - DRY VERSION

Accuracy	: ±3% of F. S.
Ambient Temperature	: Maximum 65°C
Process Temperature	: Maximum 65°C
Window	: Polycarbonate Dome
Dampening Liquids	: Dielectric Oil (Optional)
Electrical Contacts*	: Refer How to Order
Other Features	: Refer Specification of Standard Version

* Please specify contact set points while ordering.

Temperature effect:

The variation of indication caused by effects of temperature is to be calculated by below formula; which is to be added in the specified accuracy while measurement :-

Formula : $\pm 0.08 \times (t_2 - t_1) \%$ of F. S.

where t_1 = reference temperature (+20°C) and t_2 = ambient temperature in °C.

Note : The addition of mechanical electric contacts affects the accuracy of instruments such that 1% becomes 1.5%, 1.6% becomes 2.4% etc. (Add the 50% of accuracy; If the contact is of the magnetically assisted type, this value can't be added within the ±5% of setting point.)



Industrix Precise Solutions Private Limited

Room No – 303, Bhumika Residency, Plot No-21, Sector-20, Roadpali, Kalamboli, Panvel (Tal.), Raigad (Dist.),
Maharashtra, India – 410218.

Mobile: +91 99309 98399 / +91 99674 97447

E-mail: admin@ipspl.in / sales@ipspl.in Website: www.ipspl.in

CIN : U52399MH2021PTC368555

DIMENSIONS - STANDARD VERSION

IPS-PS-21

TYPE 2

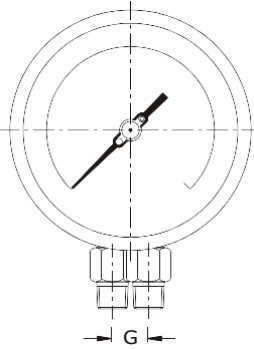
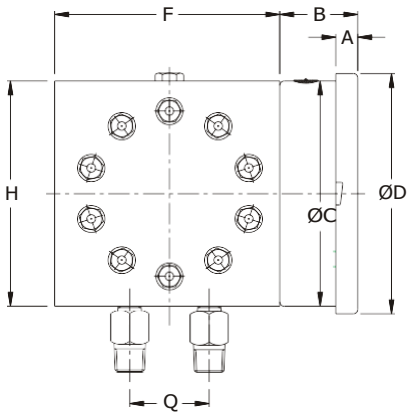

LOW PRESSURE CHAMBER

NS	A	B	ØC	ØD	F	H	G	Q	Weight in gram (With Box)
100	12.5	48	100	111	150	150	24	54	8100.0
150	15	49	149	161	150	150	24	54	8260.0

TYPE 6

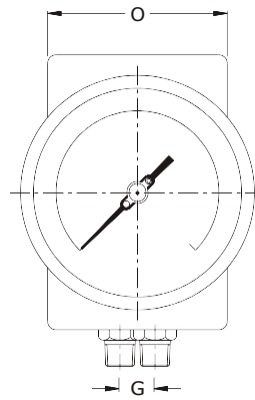
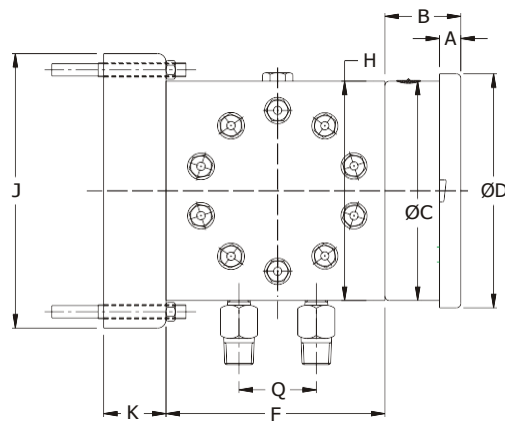

LOW PRESSURE CHAMBER

NS	A	B	ØC	ØD	F	H	G	Q	J	K	O	Weight in gram (With Box)
100	12.5	48	100	111	150	150	24	54	161	39	101	9000.0
150	15	49	149	161	150	150	24	54	161	39	101	9250.0

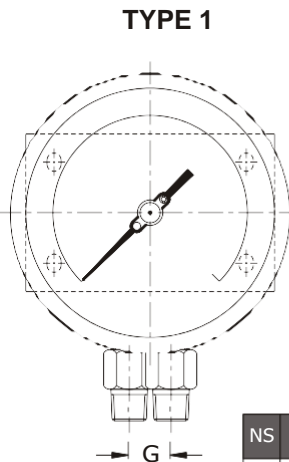
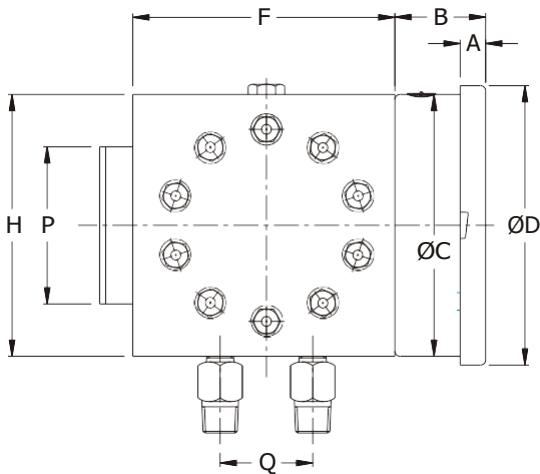

TYPE 1

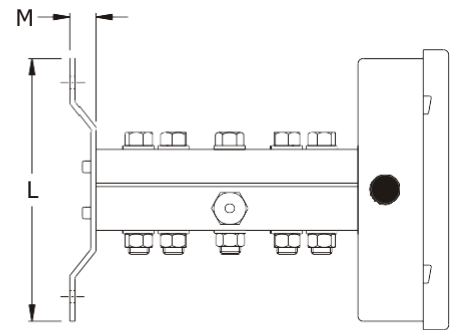

LOW PRESSURE CHAMBER

NS	A	B	ØC	ØD	F	H	G	Q	P	M	L	Weight in gram (With Box)
100	12.5	48	100	111	150	150	24	54	90	15	150	8410.0
150	15	49	149	161	150	150	24	54	90	15	150	8560.0

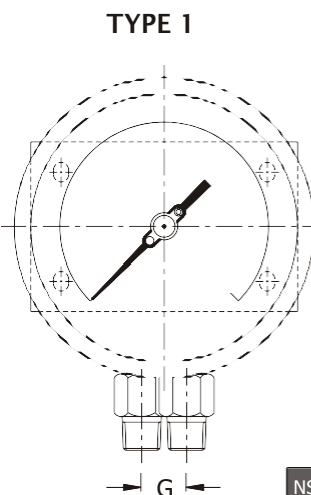
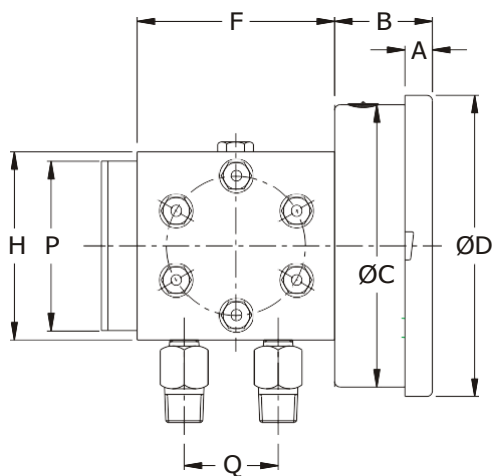

TYPE 1

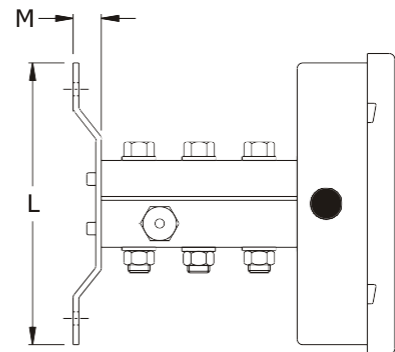

HIGH PRESSURE CHAMBER

NS	A	B	ØC	ØD	F	H	G	Q	P	M	L	Weight in gram (With Box)
100	12.5	48	100	111	105	100	25	54	90	15	150	4610.0
150	15	49	149	161	105	100	25	54	90	15	150	4760.0

SINGLE DIAPHRAGM TYPE



IPS-PS-21

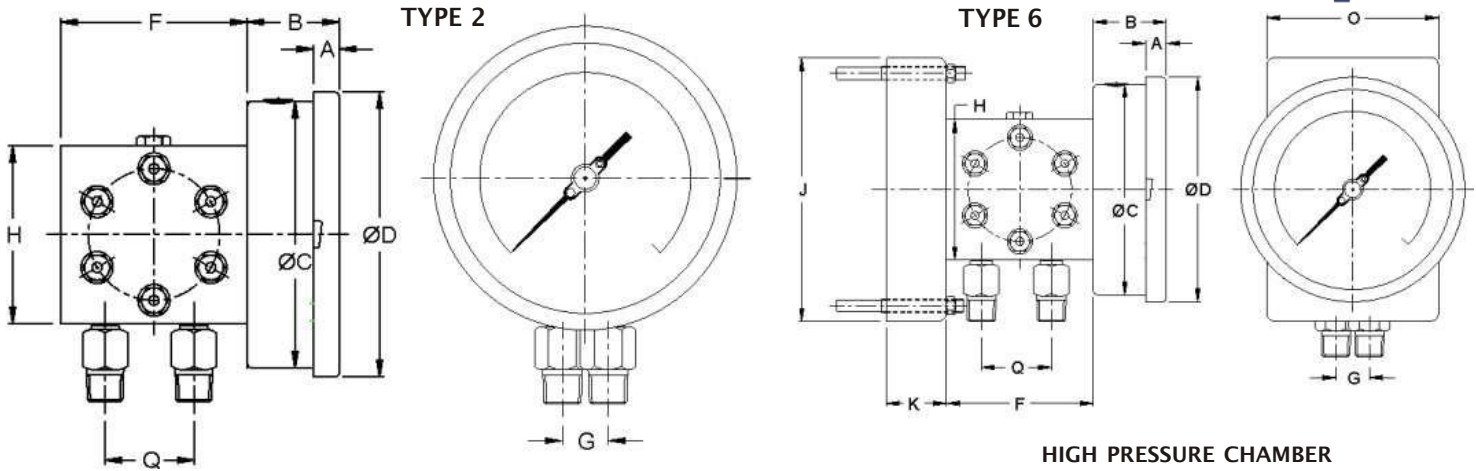

HIGH PRESSURE CHAMBER

HIGH PRESSURE CHAMBER									
NS	A	B	ØC	ØD	F	H	G	Q	Weight in gram (With Box)
100	12.5	48	100	111	105	100	25	54	4250.0
150	15	49	149	161	105	100	25	54	4400.0

NS	A	B	ØC	ØD	F	H	G	Q	J	K	O	Weight in gram (With Box)
100	12.5	48	100	111	105	100	25	54	161	39	101	5000.0
150	15	49	149	161	105	100	25	54	161	39	101	5250.0

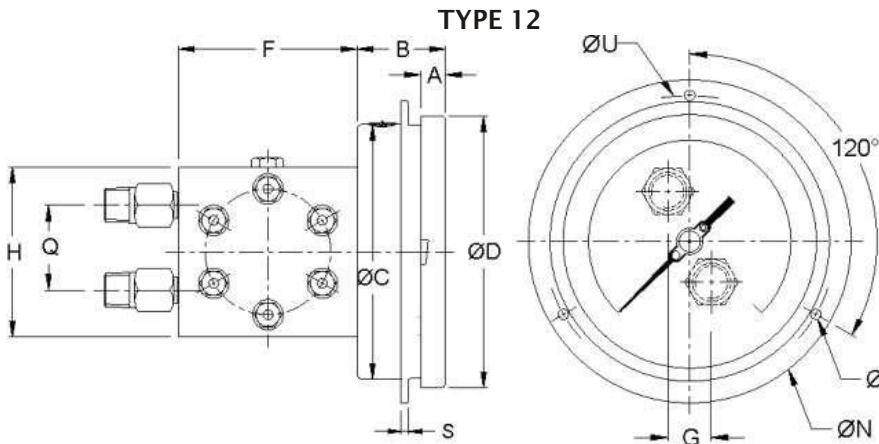

HIGH PRESSURE CHAMBER

NS	A	B	ØC	ØD	S	ØI	ØN	ØU	F	H	G	Q	Weight in gram (With Box)
100	12.5	48	100	111	1	6	134	118	105	100	25	54	4250.0
150	15	49	149	161	1	6	186	168	105	100	25	54	4400.0

Notes : • Drawings are not to scale. • All Dimensions are in mm. • NS = Nominal Size.

RANGE TABLE

Note : IPSPL offers National / International Scales like kPa, MPa, bar, psi, kg/cm², mbar, mWC, inWC & Dual Scale like kPa with psi, kPa with bar, bar with psi or Equivalent scales as per the requirement can be provided on request. Following are the example tables for kg/cm² & mmWC

PRESSURE RANGE (Single Scale)

Low Pressure			High Pressure		
mmWC	mmWC	mmWC	kg/cm ²	kg/cm ²	kg/cm ²
0/250	0/1000	0/4000	0/1	0/2.5	0/10
0/400	0/1600	0/6000	0/1.6	0/4	0/16
0/600	0/2500		0/2	0/6	0/25

Note : Other Scale are available on customer request.

ACCESSORIES (Refer Datasheet for complete specifications)

* MANIFOLDS

* Refer catalogue for Valves & Manifolds



IndustriX Precise Solutions Private Limited

Room No – 303, Bhumika Residency, Plot No-21, Sector-20, Roadpali, Kalamboli, Panvel (Tal.), Raigad (Dist.), Maharashtra, India – 410218.

Mobile: +91 99309 98399 / +91 99674 97447

E-mail: admin@ipspl.in / sales@ipspl.in Website: www.ipspl.in

CIN : U52399MH2021PTC368555

WIRING DIAGRAMS FOR ELECTRIC CONTACTS

IPS-PS-21

SINGLE CONTACT

1 NO

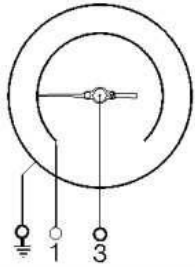

Opening

1 NC

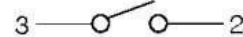
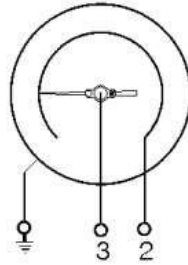

Closing

DOUBLE CONTACT

1 NO + 1 NC

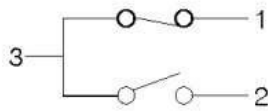
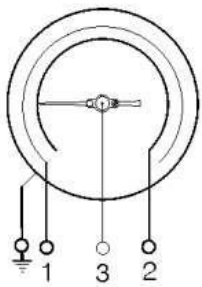

Opening 1
Closing 2

1 NC + 1 NC

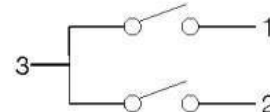
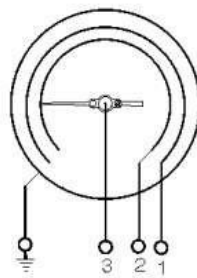

Closing 1
Closing 2

1 NC + 1 NO

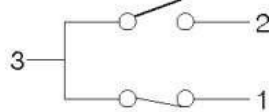
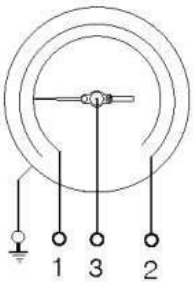

Closing 2
Opening 1

1 NO + 1 NO

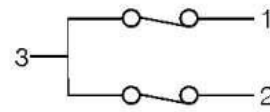
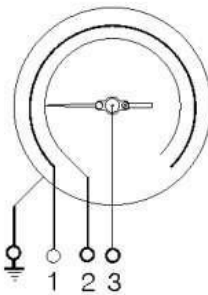

Opening 1
Opening 2

INDEPENDENT DOUBLE CONTACT

1 NO+ 1 NC

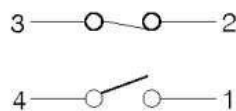
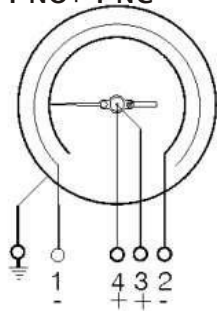

Opening 1
Closing 2

1 NC + 1 NC

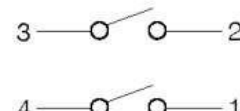
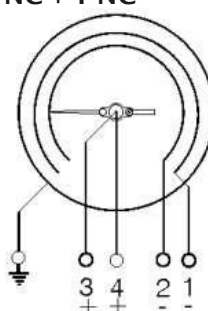

Closing 1
Closing 2

HOW TO ORDER

[It is recommended to use manifolds along with Differential Pressure Gauges for better performance and safety.]

BASIC MODEL

CODE

NOMINAL SIZE

F	H
100 mm	150 mm

TYPE OF MOUNTING

- 1 WALL / SURFACE / PROJECTION MOUNTING WITH BOTTOM ENTRY
- 2 DIRECT BOTTOM ENTRY
- 6 2" PIPE / YOKE MOUNTING BOTTOM ENTRY (Mounting bracket will be provided of steel epoxy painted.)
- 12 CENTER BACK ENTRY WITH FRONT FLANGE (Suitable for High Pressure Chamber Only)

GAUGE CONNECTION (Though adaptors)

4BM 1/4" NPT (M) x 1/2" BSP (M) X 2 Nos. 4NM 1/4" NPT (M) x 1/2" NPT (M) X 2 Nos. 2NF 1/4" NPT (F) (Standard)*

* These female connections are directly provided on chamber.

Note : Connections like Metric/ PT/ PF/ Flaired/ UNF/ G/ R etc can be provided on request.

DIAPHRAGM

UJ AISI 316L SS (Standard) UM MONEL

SEAL CHAMBER

CY AISI 304 SS (Standard) RB AISI 316 SS RD MONEL

RANGE

REFER RANGE TABLE

OPTIONS

- | | |
|--|-----------------------------|
| PS AISI 316 SS CASE & BEZEL | RZ TOUGHENED GLASS |
| PW FIVE POINT CALIBRATION CERTIFICATE | RH CUSTOM DESIGNED DIAL |
| PY DAMPENING LIQUID GLYCERINE FILLED | RW PLEXI GLASS |
| QA DAMPENING LIQUID SILICON OIL** | SW DIAL TAG MARKING |
| GH MATERIAL TEST CERTIFICATES# | SX SS TAG PLATE |
| SJ MAXIMUM READING POINTER WITH PLEXI GLASS (FOR DRY VERSION)* | TF TESTED TO NACE STANDARDS |
| JU 2" PIPE/YOKE MOUNTING BRACKET & 'U' CLAMP (AISI 304 SS) | ZZ DIELECTRIC OIL FILLED** |
| FN 2" PIPE/YOKE MOUNTING BRACKET & 'U' CLAMP (AISI 316 SS) | |

* For ranges 2.5 kg/cm² and above. ** Gasket & Plug of NBR. Refer Price List for Viton.

MATERIAL TEST CERTIFICATES WILL BE PROVIDED FOR WETTED PARTS ONLY WITH CHEMICAL COMPOSITION TESTING. FOR OTHERS, PLEASE CONSULT FACTORY.

ELECTRIC CONTACTS (C E & ATEX APPROVED)

(FOR DRY VERSION, WITH INGRESS PROTECTION UP TO IP 55 & POLY CARBONATE DOME AS A WINDOW)

A) SINGLE INSULATED MAGNETIC SNAP ACTION TYPE*
(230 V AC, 1 Amp.)(48 V DC, 0.5 Amp.)
(AVAILABLE FOR 1 kg/cm² & ABOVE)

B) INDUCTIVE TYPE (220 V AC, 0.4 Amp.)
(AVAILABLE FOR 1000 mmWC & ABOVE)

- RJ Single; NORMALLY CLOSED (1 NC)
- RK Double; NORMALLY CLOSED + NORMALLY OPEN (1 NC +1 NO)
- RL Single; NORMALLY OPEN (1 NO)
- RM Double; NORMALLY OPEN + NORMALLY CLOSED (1 NO + 1 NC)
- RN Double; NORMALLY CLOSED (BOTH NC)
- RO Double; NORMALLY OPEN (BOTH NO)
- RU BOOSTER WITH RELAY FOR CURRENT UPTO 5 Amp.
- RA SPDT
- RC DPDT

- YW Single; NORMALLY OPEN (1 NO)
- YV Single; NORMALLY CLOSED (1 NC)
- YX Double; NORMALLY CLOSED + NORMALLY OPEN (1 NC +1 NO)
- YY Double; NORMALLY OPEN (BOTH NO)
- YZ Double; NORMALLY CLOSED (BOTH NC)
- ZA Double; NORMALLY OPEN + NORMALLY CLOSED (1 NO + 1 NC)

* FOR DOUBLE INSULATED ELECTRICAL CONTACTS, CONSULT FACTORY FOR PRICE & DELIVERY.

FOR OTHER OPTIONAL ITEMS, PLEASE CONTACT FACTORY FOR DELIVERY AND MINIMUM QUANTITY OF ORDER.

☆ FOR DIAPHRAGM SEALS, VALVES & MANIFOLDS, REFER INDIVIDUAL DATA SHEETS.

(THE CAPILLARY LENGTH SHALL BE MAXIMUM UP TO 3 METERS & RANGE SHALL BE ABOVE 1 kg/cm².)

Note : Specifications and dimensions given in this product catalogue represents the state of engineering at the time of printing.

Modifications may take place and materials specified may be replaced by others without prior notice.

IPS-PG-21

XX

X

X
OR
XX

XXX

XX

XX

0 - 2
kg/cm²

XX

XX



IndustriX Precise Solutions Private Limited

Room No – 303, Bhumika Residency, Plot No-21, Sector-20, Roadpali, Kalamboli, Panvel (Tal.), Raigad (Dist.), Maharashtra, India – 410218.

Mobile: +91 99309 98399 / +91 99674 97447

E-mail: admin@ipspl.in / sales@ipspl.in Website: www.ipspl.in

CIN : U52399MH2021PTC368555